

SPECIFICATION

| | |
|--------------|--|
| Part No. | : MA104.C.AB.015 |
| Product Name | : MA104 GPS/Cellular Combination Hercules Screw-mount [Permanent mount] |
| Feature | : Low profile - Height 29 mm and Diameter 49mm Heavy duty screw mount UV and vandal resistant PC housing Cellular -Penta Band Antenna 850/900/1800/1900/2100/1575.42 MHz GSM/GPRS/CDMA/EVDO/UMTS/HSPA/WCDMA GPS - Two Stage 28dB+ LNA IP67 & IP69K compliance Standard is 3 metres RG174 SMA(M) Cables and connectors are fully customizable ROHS Compliant |



1. Introduction

The MA.104.C GPS/Cellular Combination Hercules Antenna is a combination high performance GPS and penta-band cellular antenna solution for reliable asset tracking and remote monitoring. Durable UV and robust PC housing is resistant to vandalism and direct attack. At only 29 mm height it complies with the latest EU height restrictions directives for roof-mounted objects, with a diameter of 49 mm. It is designed to not catch on tree-branches.

The Hercules can be mounted on metal or non-metal structures as it has a metal ground-plane base integrated inside.

2. Specification

| ELECTRICAL CELLULAR | | | | | | |
|----------------------|-----|---------------|---------|-----------|-----------|-------------|
| Standard | | AMPS | GSM | PCS | DCS | 3G |
| Band (MHz) | | 850 | 900 | 1900 | 1800 | 2100 |
| Frequency (MHz) | | 824-896 | 880-960 | 1850-1990 | 1710-1880 | 1920 – 2170 |
| Return Loss (dB) | | | | | | |
| Cable length (meter) | 0.3 | -6.5 | -6.0 | -7 | -8 | -5 |
| | 1.0 | -9.5 | -8 | -17 | -16 | -15 |
| | 2.0 | -10 | -9 | -20 | -21 | -18 |
| | 3.0 | -13 | -11 | -21 | -21 | -19 |
| | 5.0 | -14 | -14 | -25 | -25 | -23 |
| Efficiency (%) | | | | | | |
| Cable length (meter) | 0.3 | 38 | 54 | 58 | 54 | 50 |
| | 1.0 | 31 | 35 | 36 | 42 | 31 |
| | 2.0 | 23 | 20 | 23 | 32 | 21 |
| | 3.0 | 25 | 29 | 23 | 22 | 18 |
| | 5.0 | 11 | 11.5 | 12 | 11 | 11 |
| Peak Gain (dBi) | | | | | | |
| Cable length (meter) | 0.3 | 2.0 | 3.3 | 4.0 | 3.6 | 3.0 |
| | 1.0 | 1.2 | 1.3 | 2 | 1.8 | 1.2 |
| | 2.0 | 0.5 | -0.35 | 0 | 1.5 | -0.1 |
| | 3.0 | 0.1 | 1.6 | 0.6 | 0.1 | -0.9 |
| | 5.0 | -2.5 | -2.4 | -2.3 | -3.0 | -2.0 |
| Polarization | | Linear | | | | |
| Impedance | | 50 Ohms | | | | |
| Input Power | | 10 Watts max. | | | | |
| VSWR | | <3.5.0:1 | | | | |

| ELECTRICAL GPS | | | |
|-----------------------------|--|-----------|-----------|
| Frequency | 1575.42MHz \pm 1.023MHz | | |
| Impedance | 50 ohm | | |
| VSWR | 2.0 Max | | |
| GPS Patch Gain | 2.0dB Passive Gain @ Zenith -1.0dBi Gain @ 10 degrees elevation | | |
| Axial ratio | 3.0 dB max | | |
| Polarization | RHCP | | |
| Out Band Rejection | fo = 1575.42MHz fo \pm 30 MHz 5dB Min. fo \pm 50 MHz 20dB Min. fo \pm 100 MHz 25dB Min. | | |
| Input Voltage | Min:1.8V | Typ. 3.0V | Max: 5.5V |
| Total Gain @ Zenith | 25dBic | 30dBic | 32dBic |
| Current Consumption | 6mA | 12mA | 30mA |
| Noise Figure | 2.7dB | 3.0dB | 3.7dB |
| MECHANICAL | | | |
| Dimensions | Height 29mm x Diameter 49mm | | |
| Casing | UV resistant PC | | |
| Base and thread | Nickel plated steel | | |
| Thread diameter | 18mm | | |
| Weather proof gasket | CR4305 foam with 3M9448B double-side adhesive | | |
| Cable pull | 8 Kgf | | |
| Recommended Mounting Torque | 24.5N·m | | |
| Max Mounting Torque | 29.4N·m | | |
| Weight | 200g | | |
| ENVIRONMENTAL | | | |
| Waterproof | IP-67 & IP-69K | | |
| Corrosion | 5% NaCl for 48hrs - Nickel plated steel base and thread | | |
| Temperature Range | -40°C to +85°C | | |
| Thermal Shock | 100 cycles -40°C to +80°C | | |
| Humidity | Non-condensing 65°C 95% RH | | |
| Shock (drop test) | 1m drop on concrete 6 axes | | |

*Note: The return loss, efficiency and gain measurements in the above table, were taken for the antenna mounted on a 30x30 cm metal plate. For a specific case performance refers to the below plots.

3. Test Set Up



Figure 1. MA104 Antenna test set up in free space, 30x30 cm metal plate and 60x60 cm metal plate, R&SZVL6 VNA (left) and R&S4100 CTIA 3D Chamber (Right).

4. Antenna Parameters

4.1 Return Loss

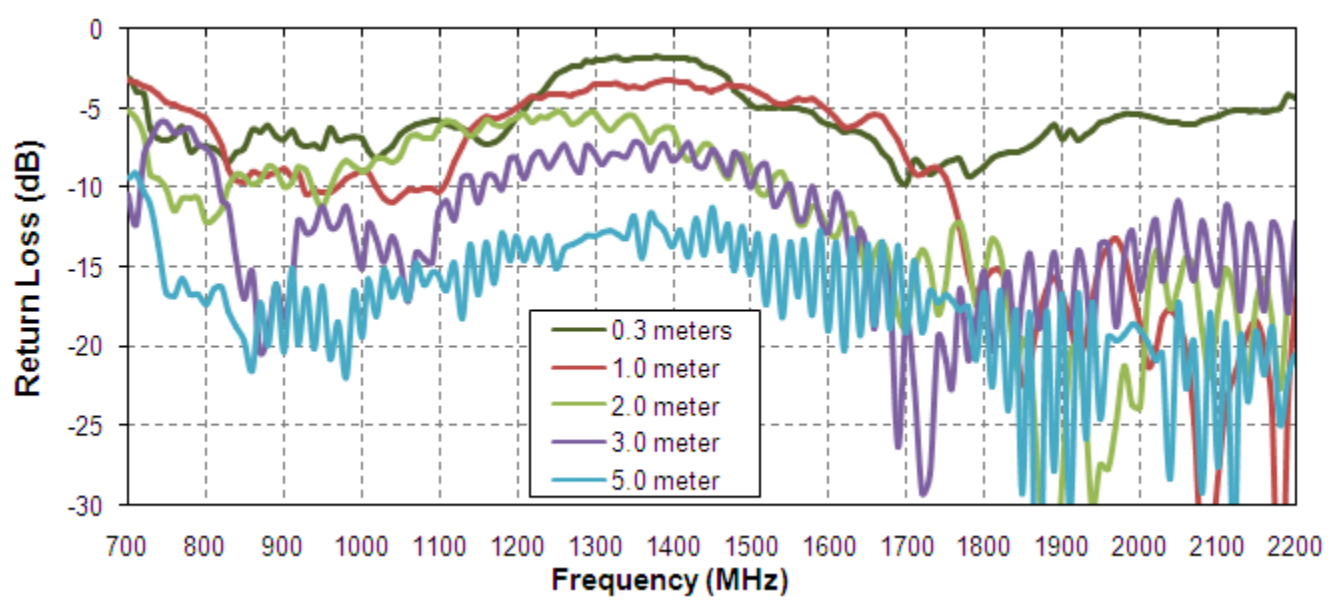

Figure 2. Return Loss of the MA104 antenna in free space

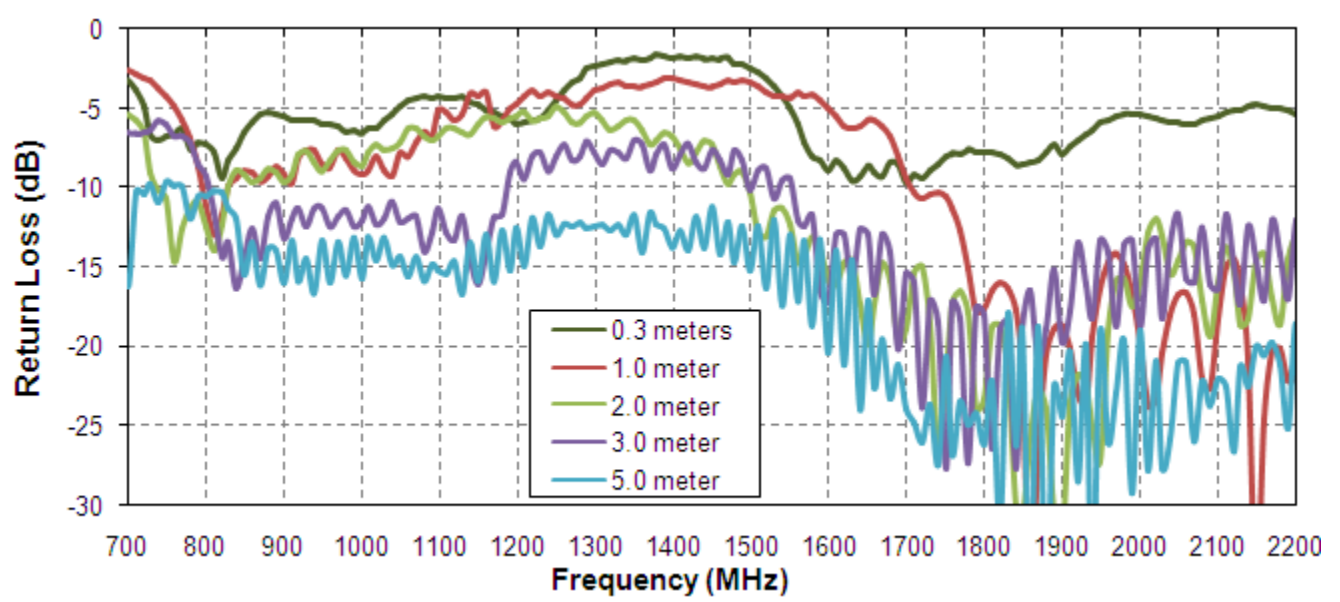

Figure 3. Return Loss of the MA104 antenna on 30*30cm metal plate

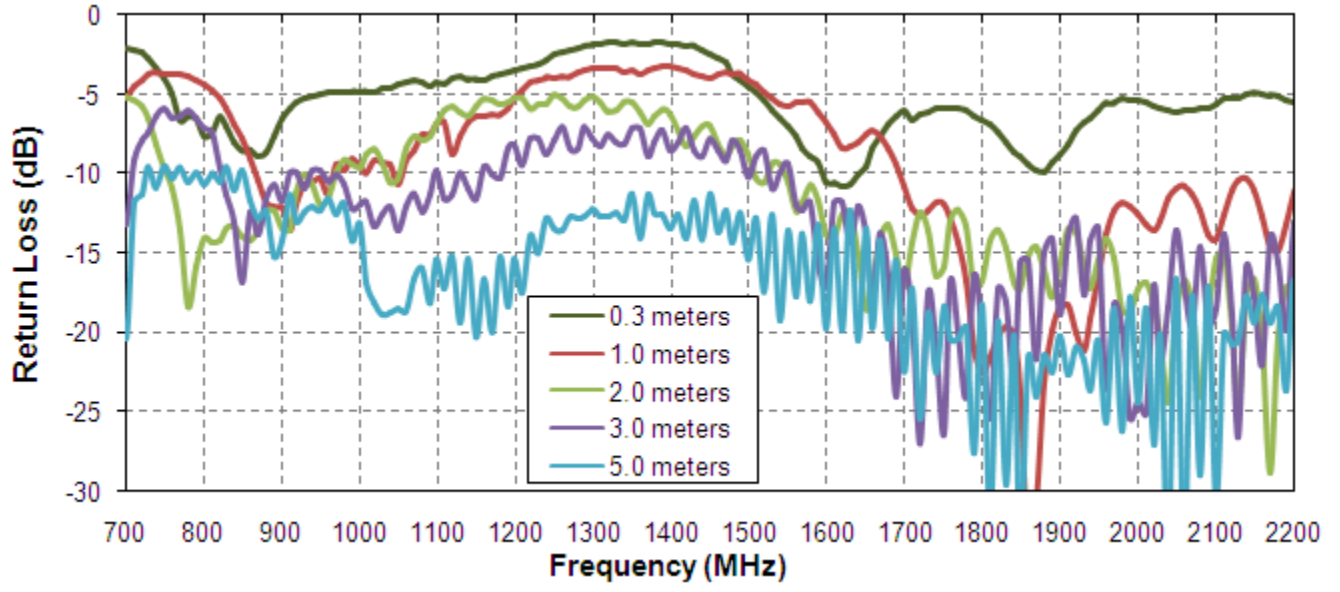

Figure 4. Return Loss of the MA104 antenna on 60*60cm metal plate

4.2 Efficiency

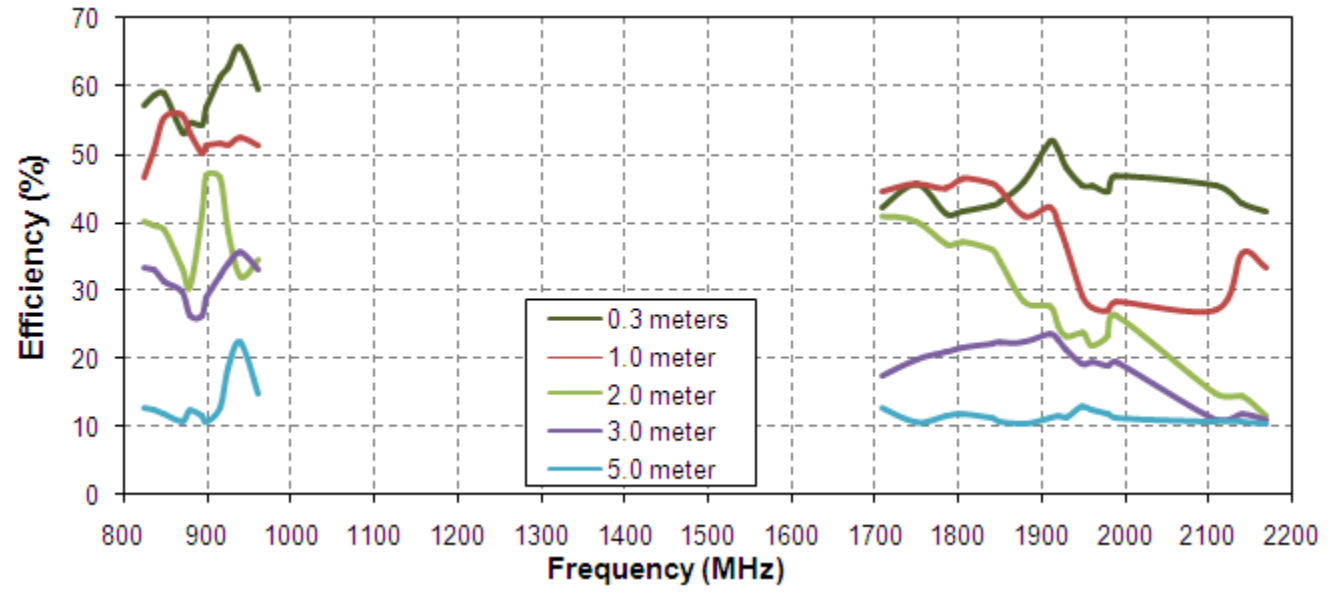

Figure 5. Efficiency of the MA104 antenna in free space

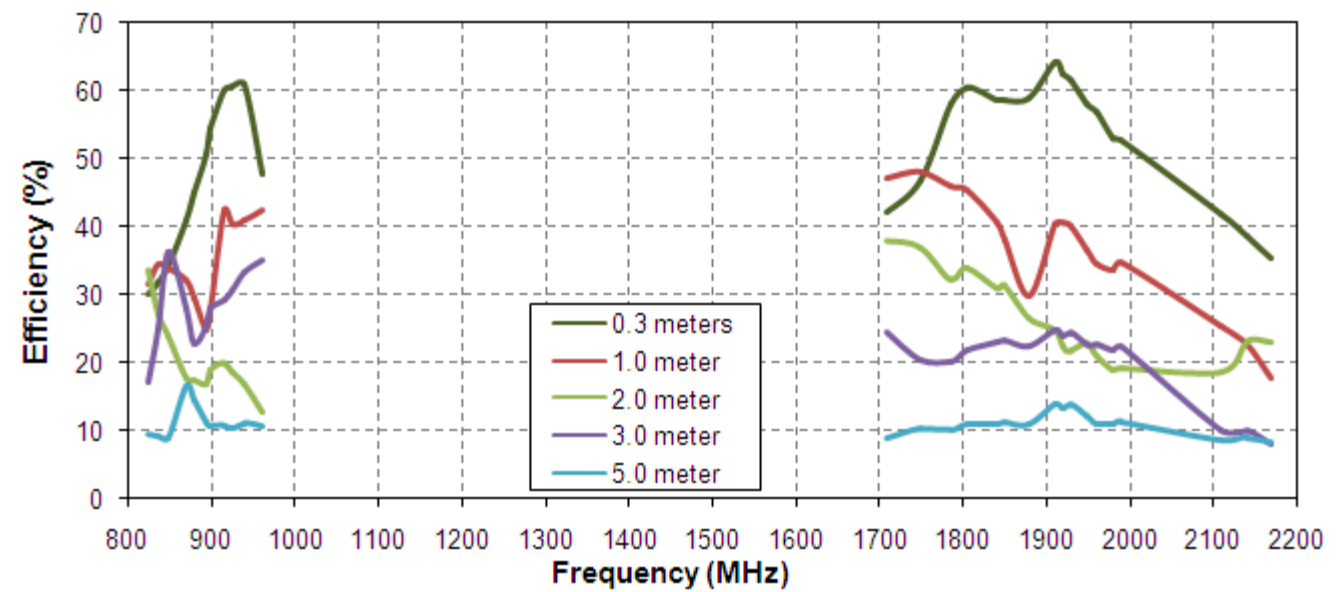

Figure 6. Efficiency of the MA104 antenna on 30*30cm metal plate

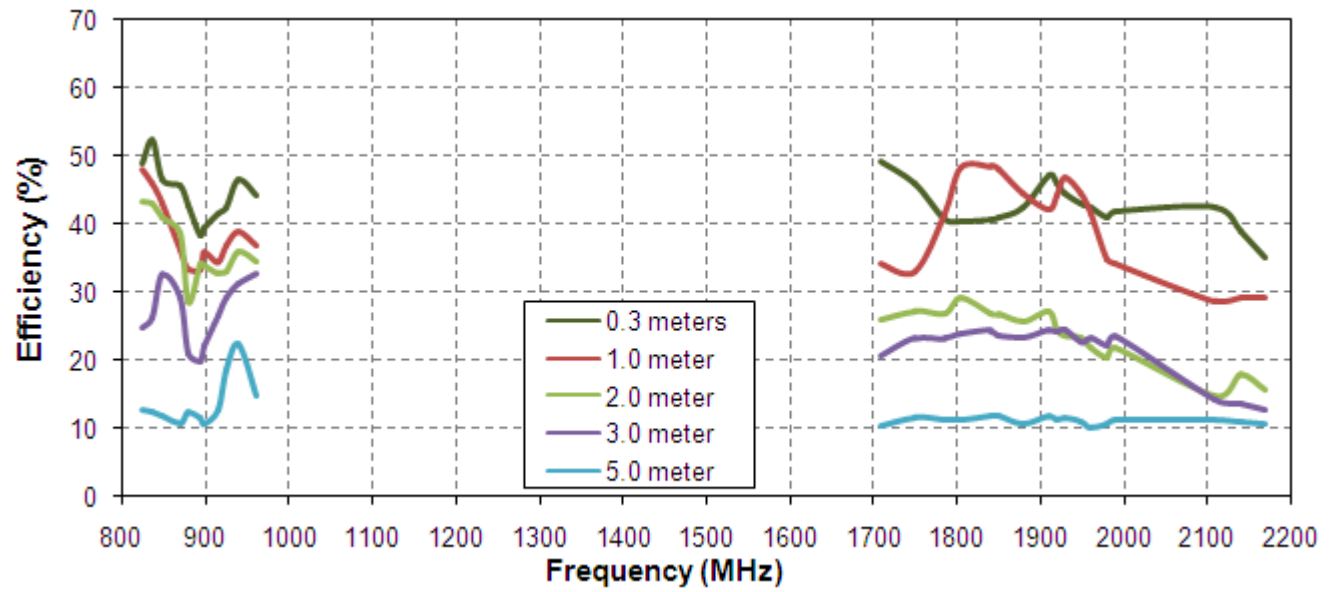

Figure 7. Efficiency of the MA104 antenna on 60*60cm metal plate.

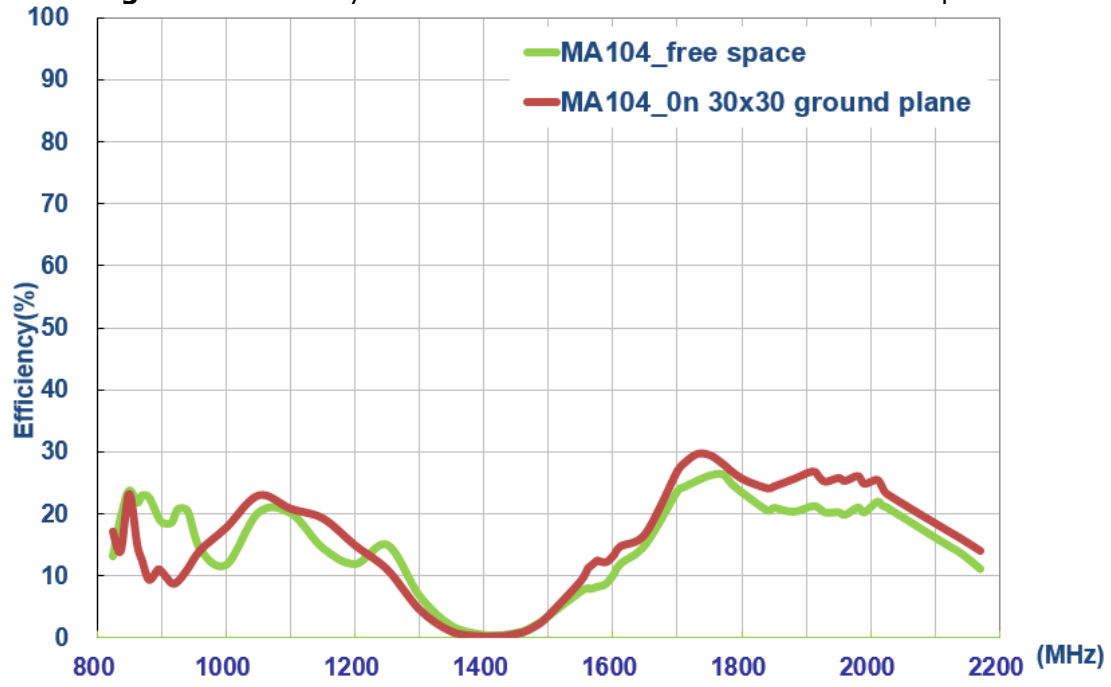

Figure 8. Efficiency of the MA104 antenna with 960~1700MHz

4.3 Peak Gain

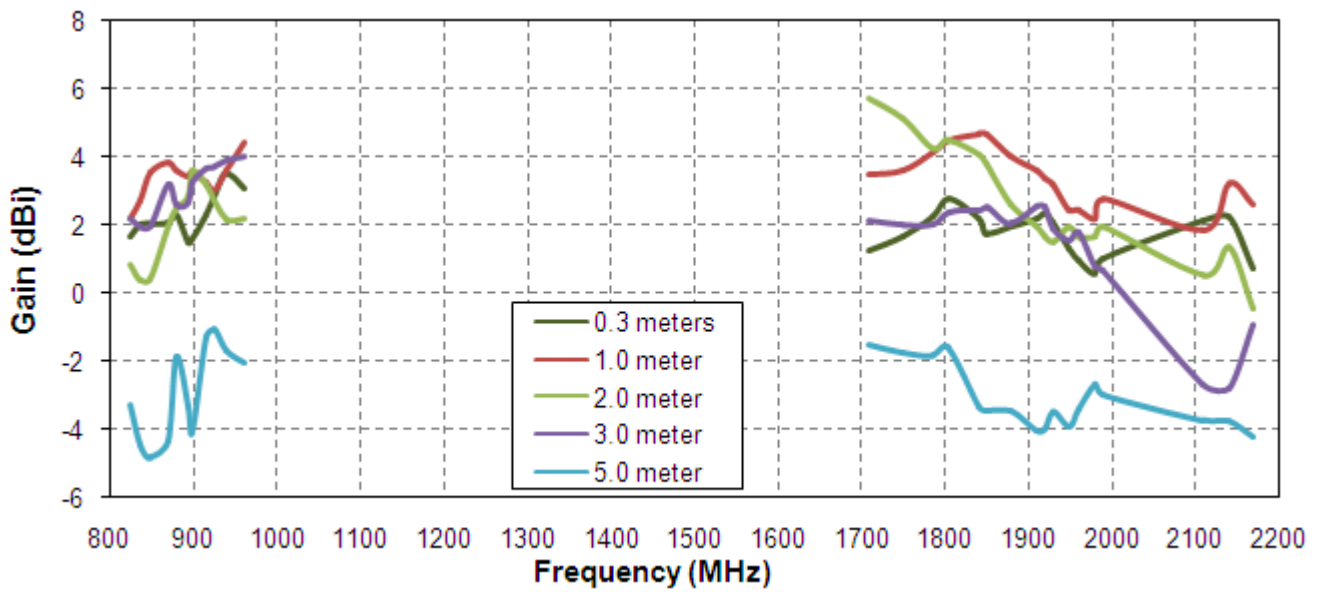

Figure 9. Gain of the MA104 antenna in free space

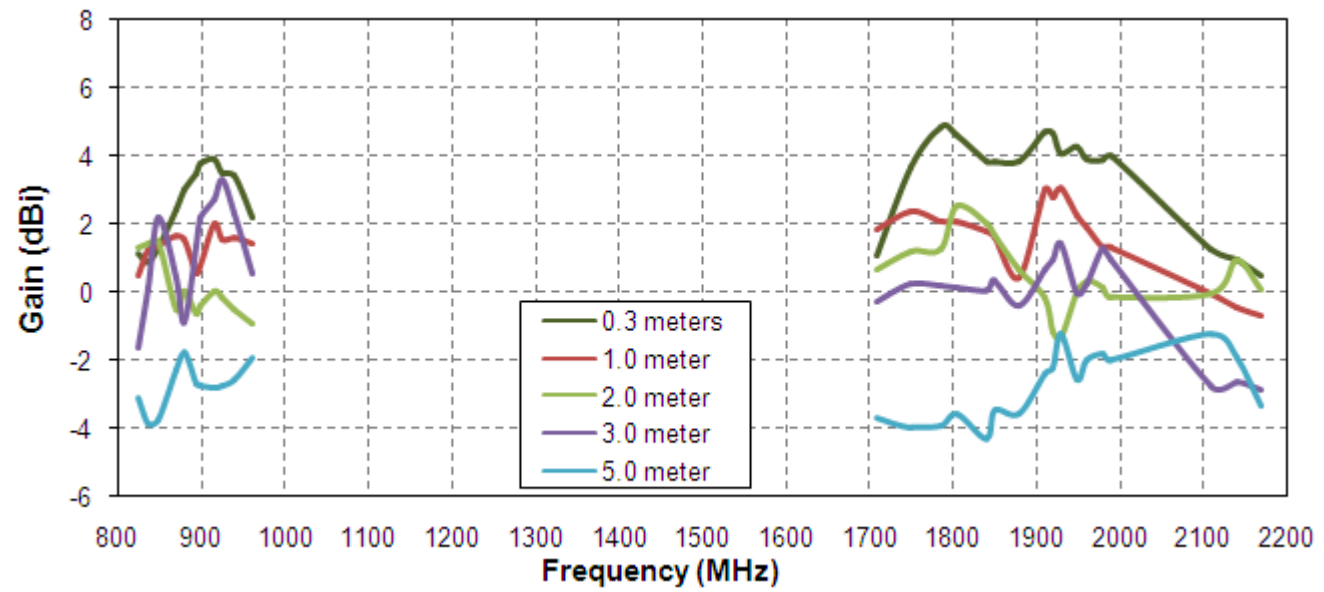

Figure 10. Gain of the MA104 antenna on 30*30cm metal plate

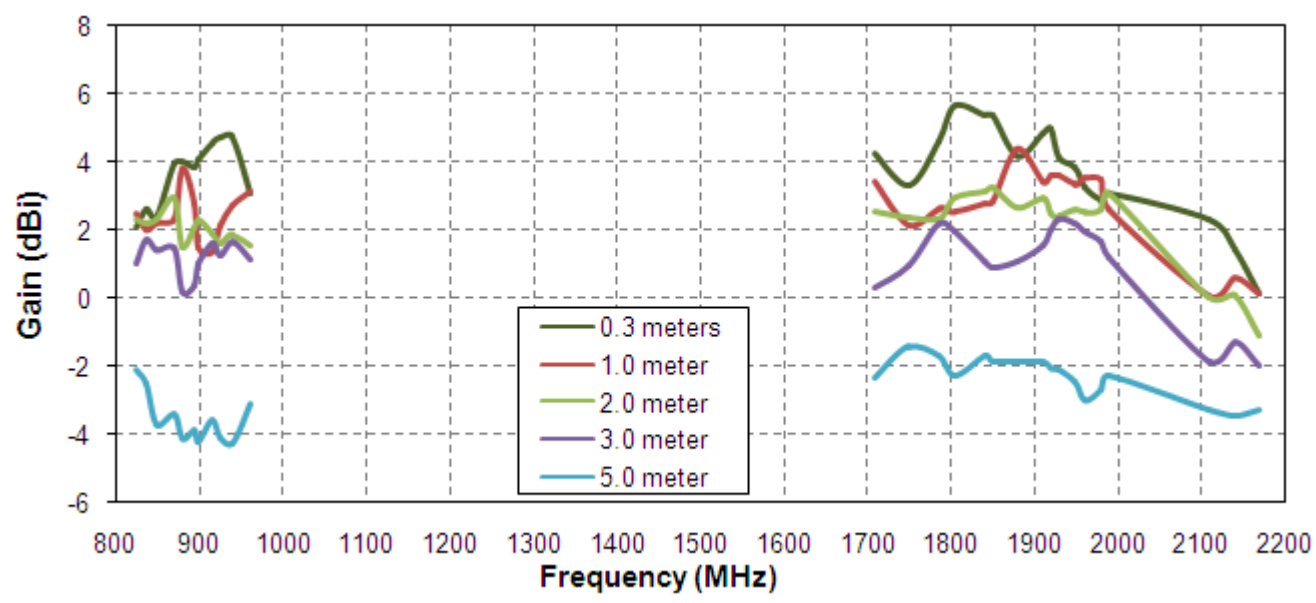

Figure 11. Gain of the MA104 antenna on 60*60cm metal plate

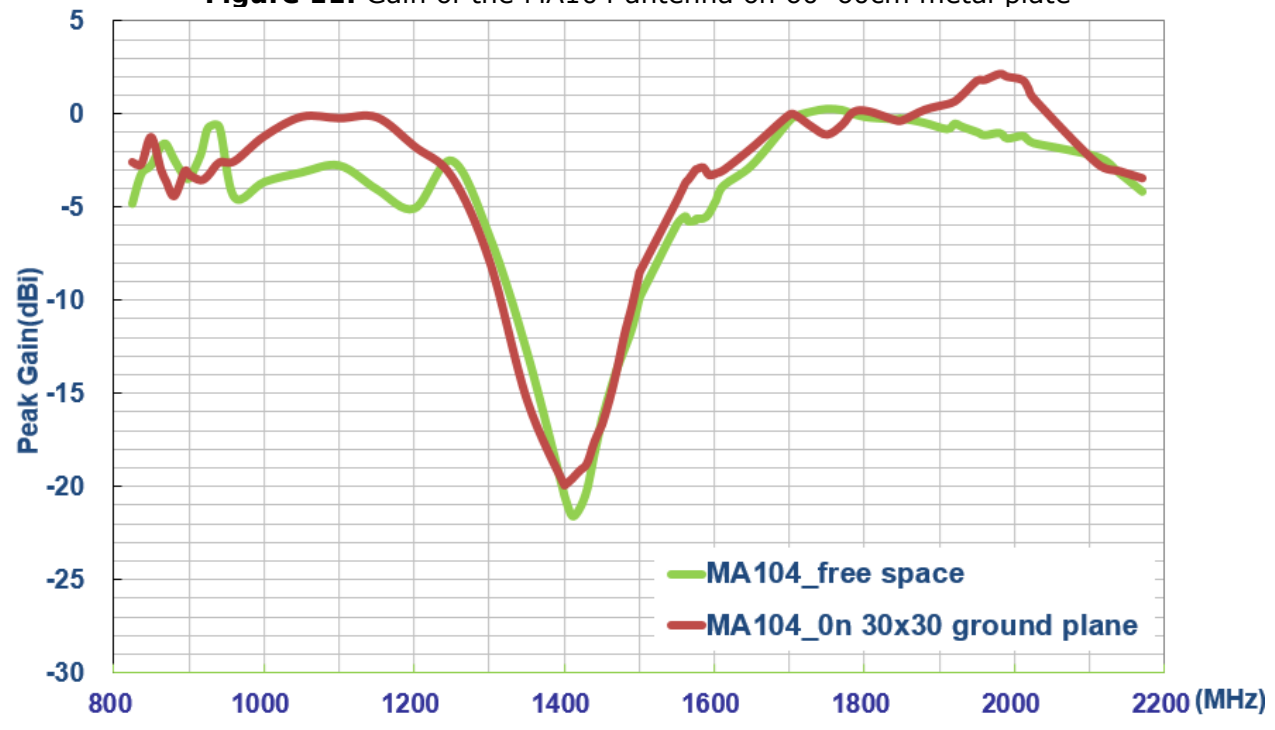

Figure 12. Gain of the MA104 antenna from 960~1700MHz

4.4 Radiation pattern

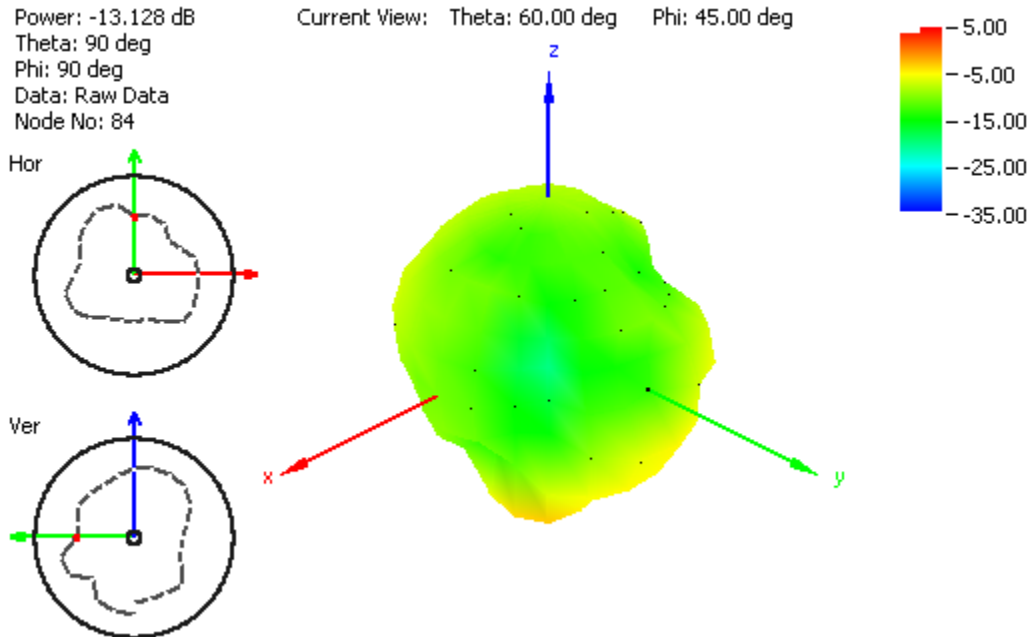

Figure 13. Radiation pattern at 849 MHz, Figure 1 as reference (dB), with 2 m RG174 cable and free space

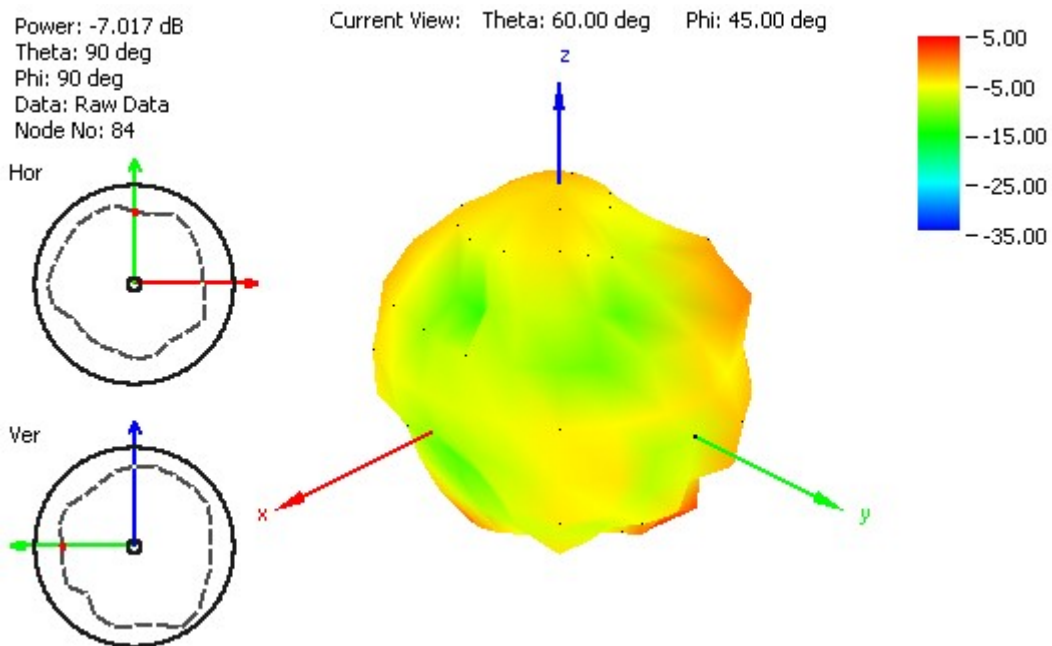

Figure 14. Radiation pattern at 915 MHz, Figure 1 as reference (dB), with 2 m RG174 cable and free space

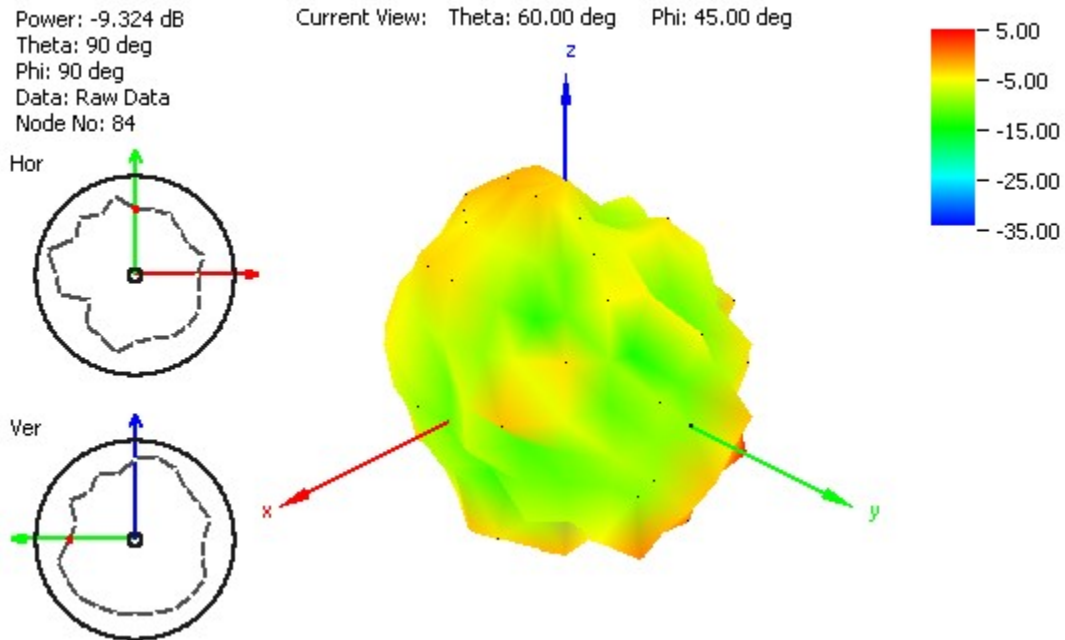

Figure 15. Radiation pattern at 1805 MHz, Figure 1 as reference (dB), with 2 m RG174 cable and free space

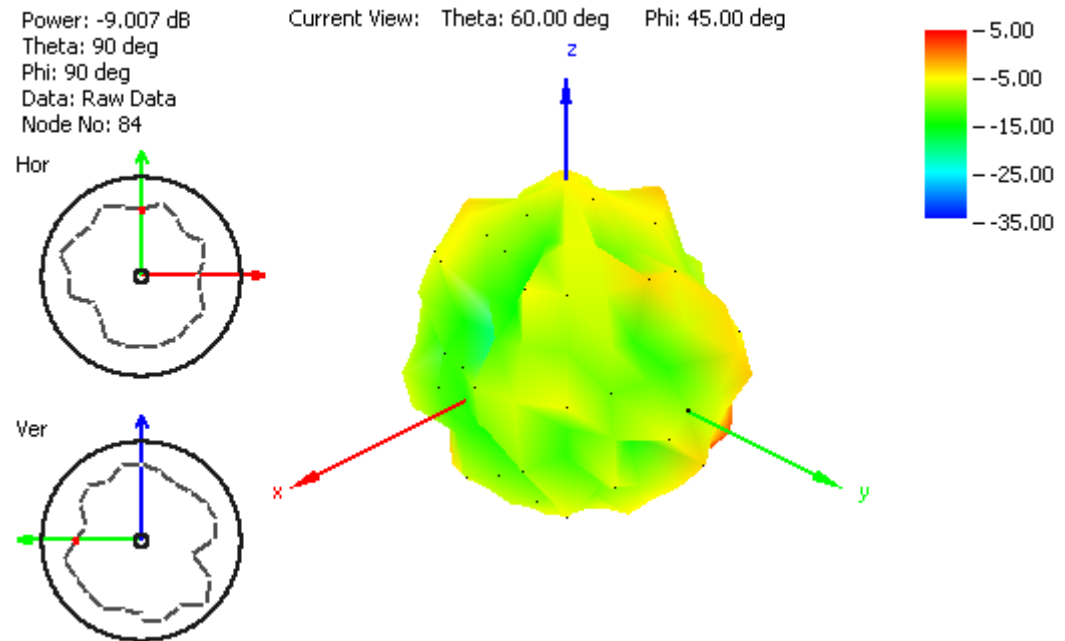

Figure 16. Radiation pattern at 1910 MHz, Figure 1 as reference (dB), with 2 m RG174 cable and free space

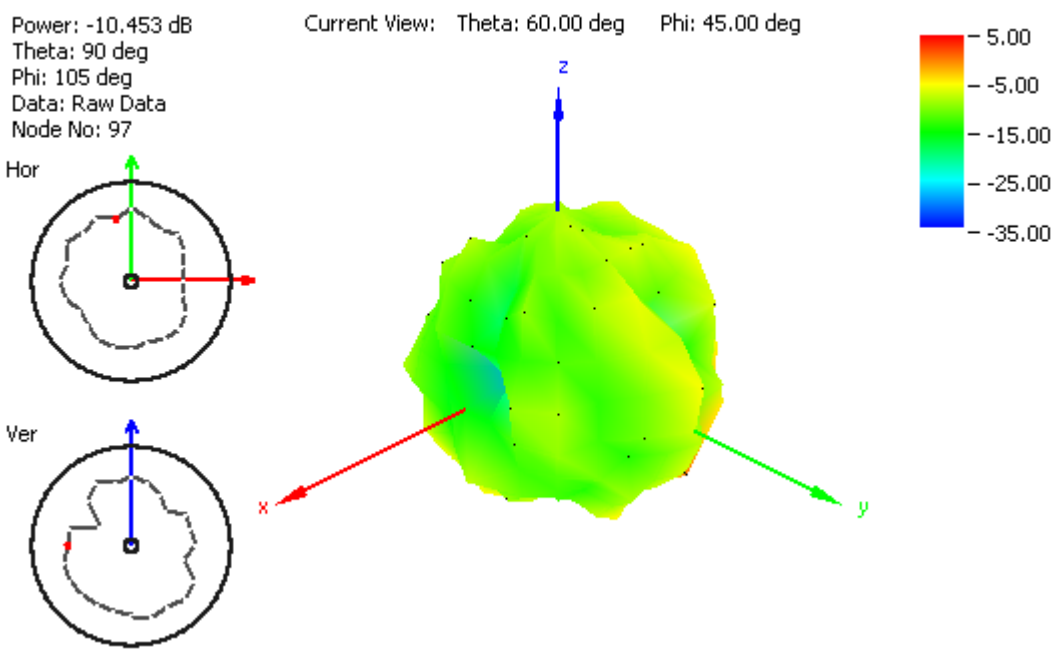

Figure 17. Radiation pattern at 2110 MHz, Figure 1 as reference (dB), with 2 m RG174 cable and free space.

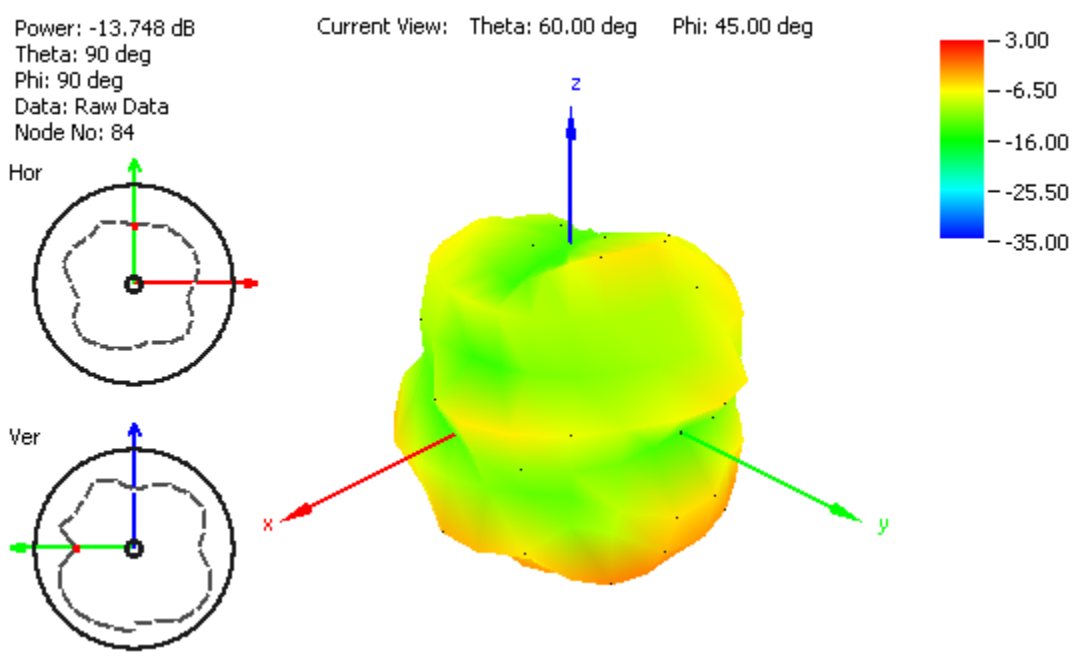

Figure 18. Radiation pattern at 849 MHz, Figure 1 as reference (dB), with 2 m RG174 cable and 30x30 cm metal plate

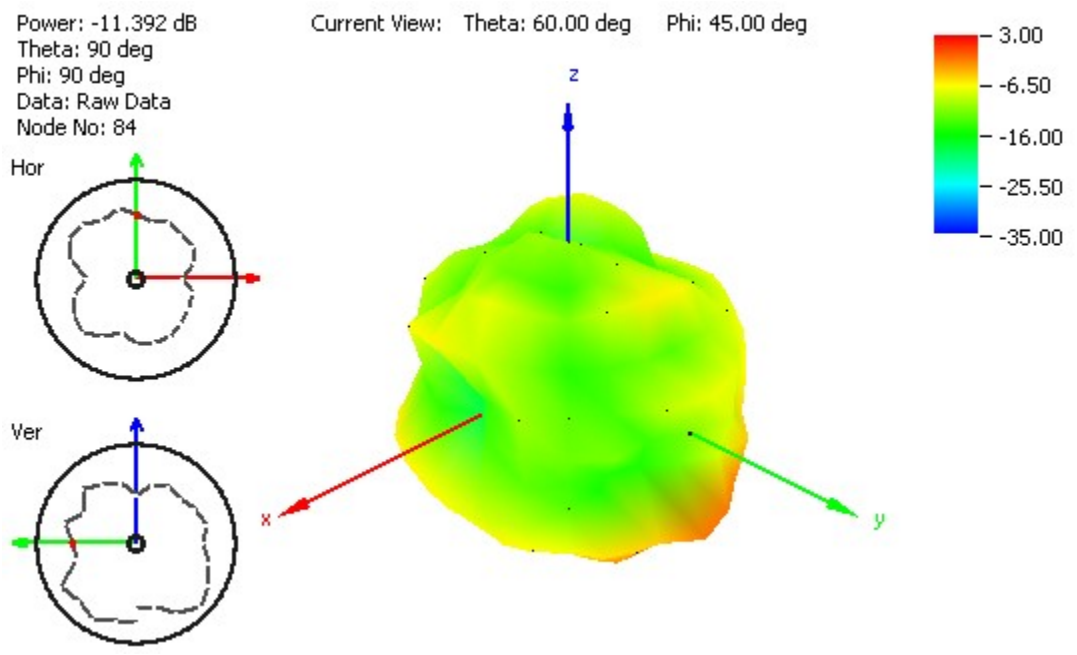

Figure 19. Radiation pattern at 915 MHz, Figure 1 as reference (dB), with 2 m RG174 cable and 30x30 cm metal plate

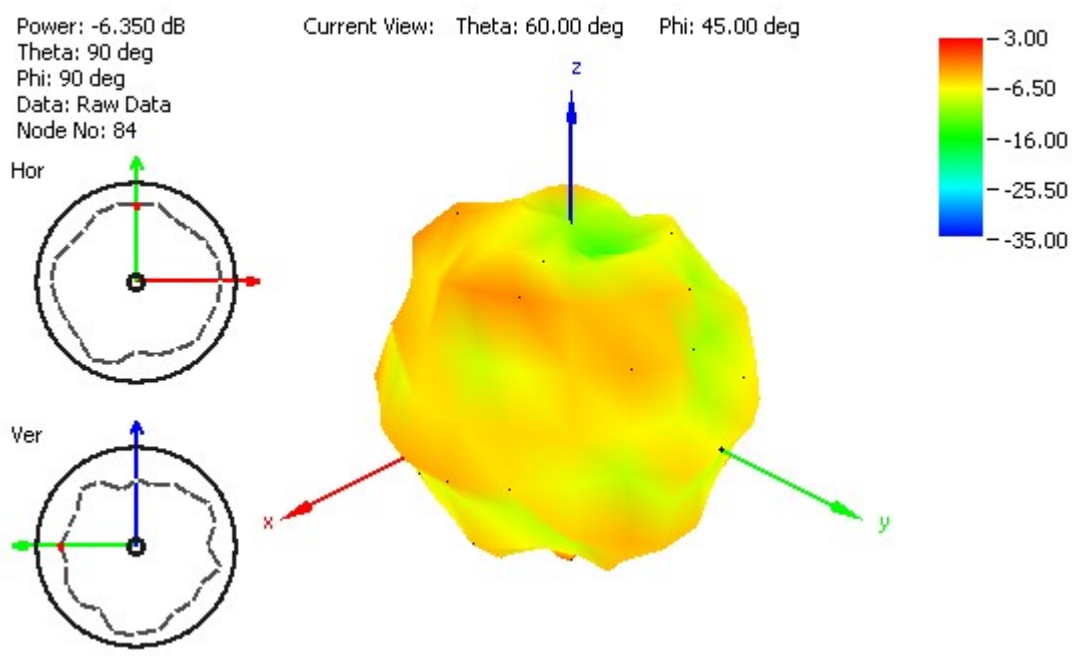

Figure 20. Radiation pattern at 1805 MHz, Figure 1 as reference (dB), with 2 m RG174 cable and 30x30 cm metal plate

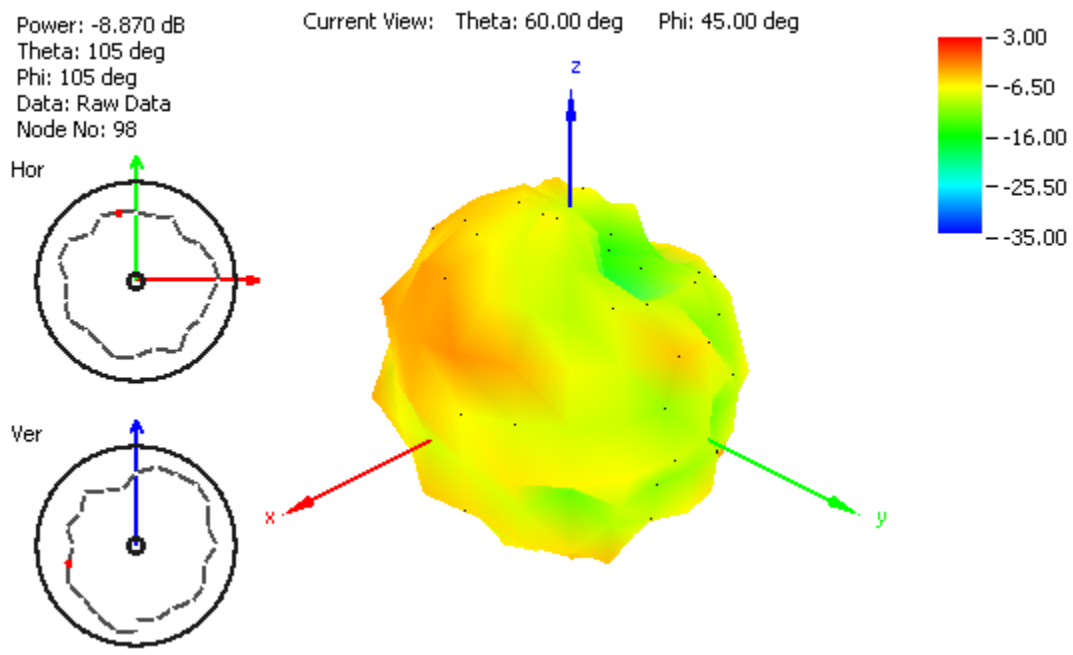

Figure 21. Radiation pattern at 1910 MHz, Figure 1 as reference (dB), with 2 m RG174 cable and 30x30 cm metal plate

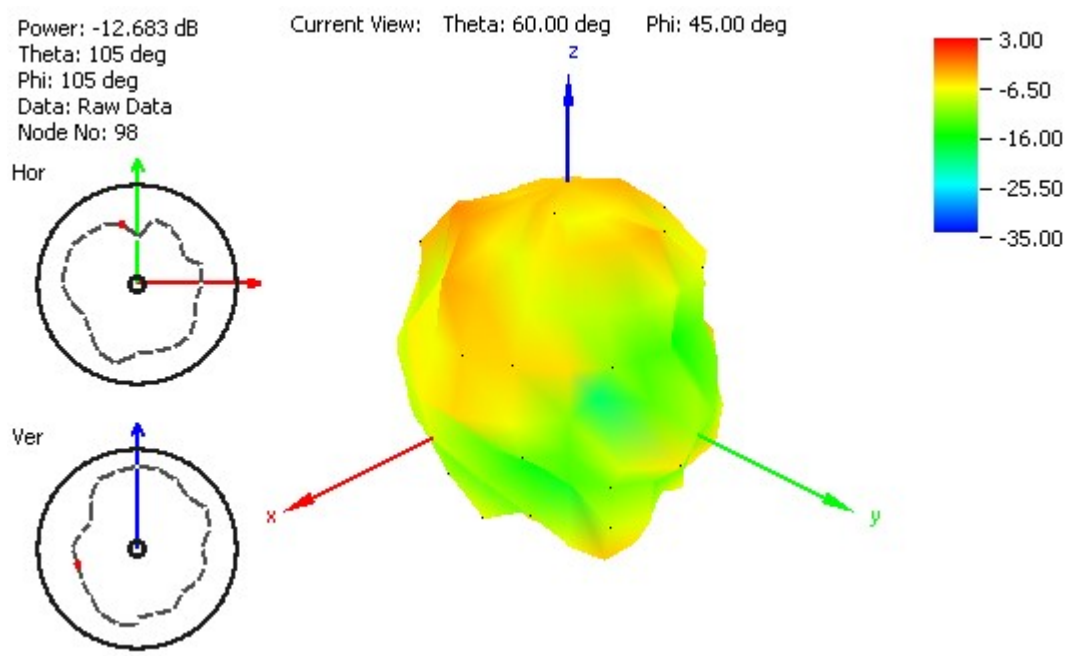

Figure 22. Radiation pattern at 2110 MHz, Figure 1 as reference (dB), with 2 m RG174 cable and 30x30 cm metal plate

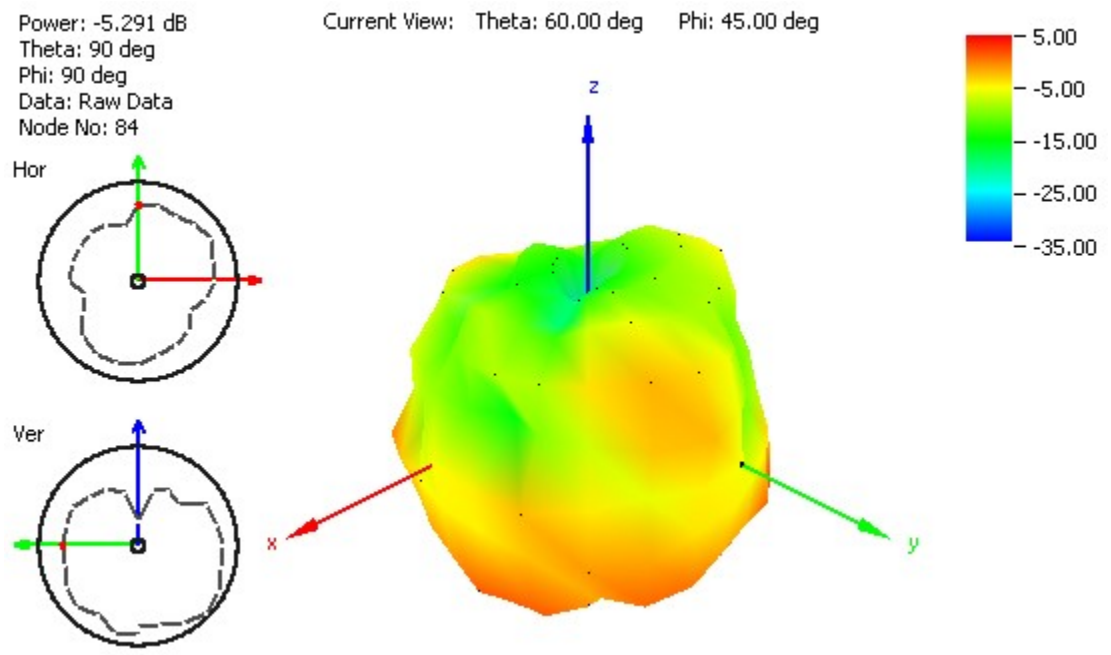

Figure 23. Radiation pattern at 849 MHz, Figure 1 as reference (dB), with 2 m RG174 cable and 60x60 cm metal plate

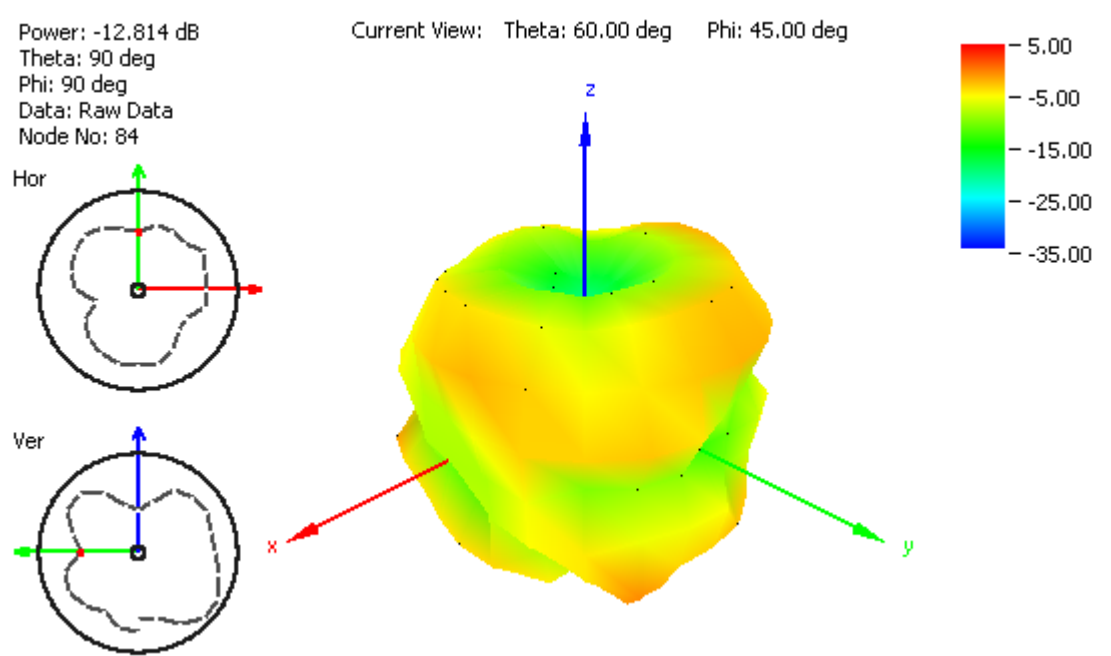

Figure 24. Radiation pattern at 915 MHz, Figure 1 as reference (dB), with 2 m RG174 cable and 60x60 cm metal plate

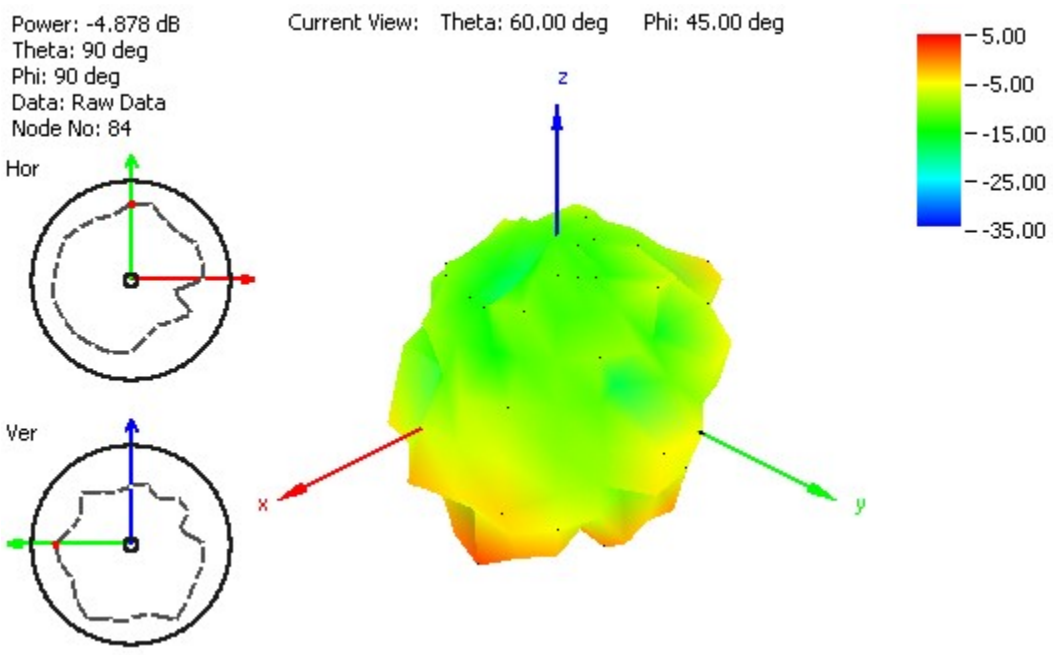

Figure 25. Radiation pattern at 1805 MHz, Figure 1 as reference (dB), with 2 m RG174 cable and 60x60 cm metal plate

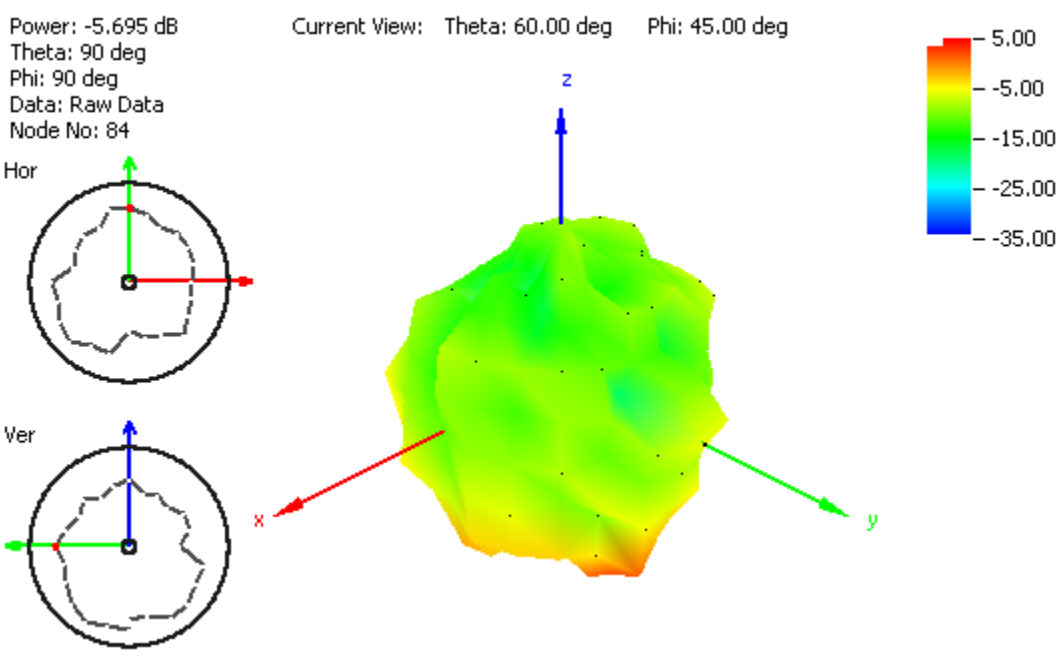

Figure 26. Radiation pattern at 1910 MHz, Figure 1 as reference (dB), with 2 m RG174 cable and 60x60 cm metal plate

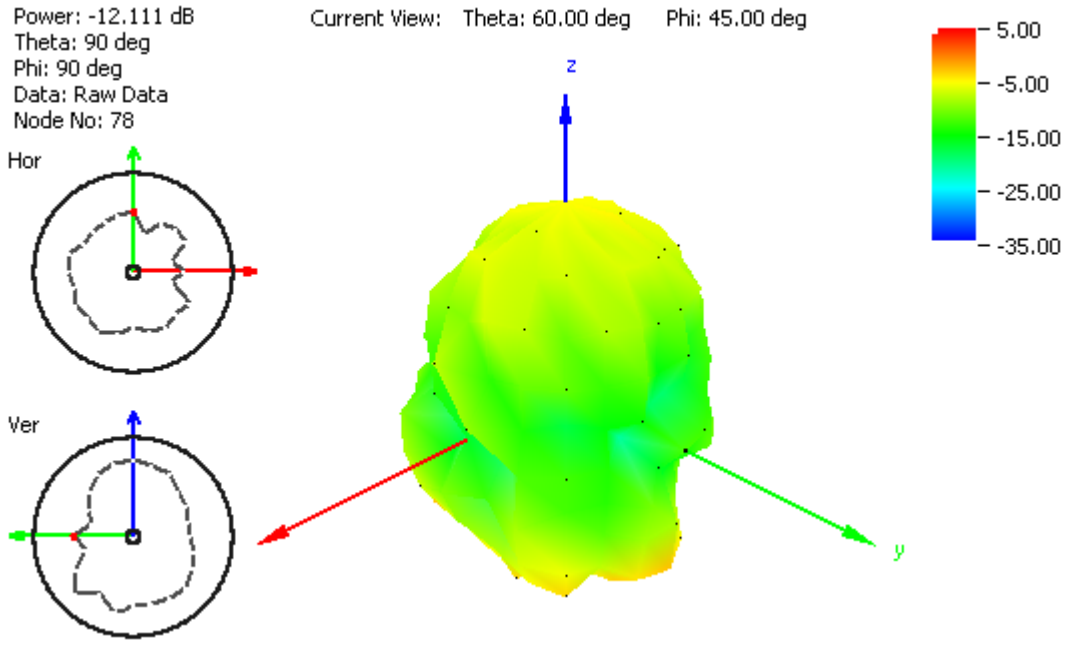
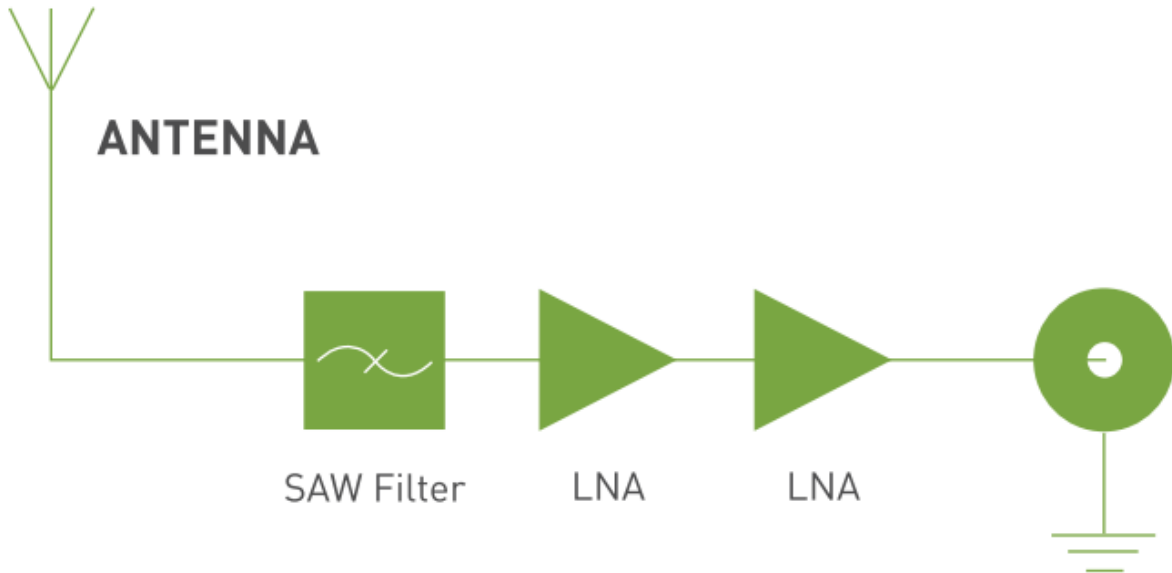
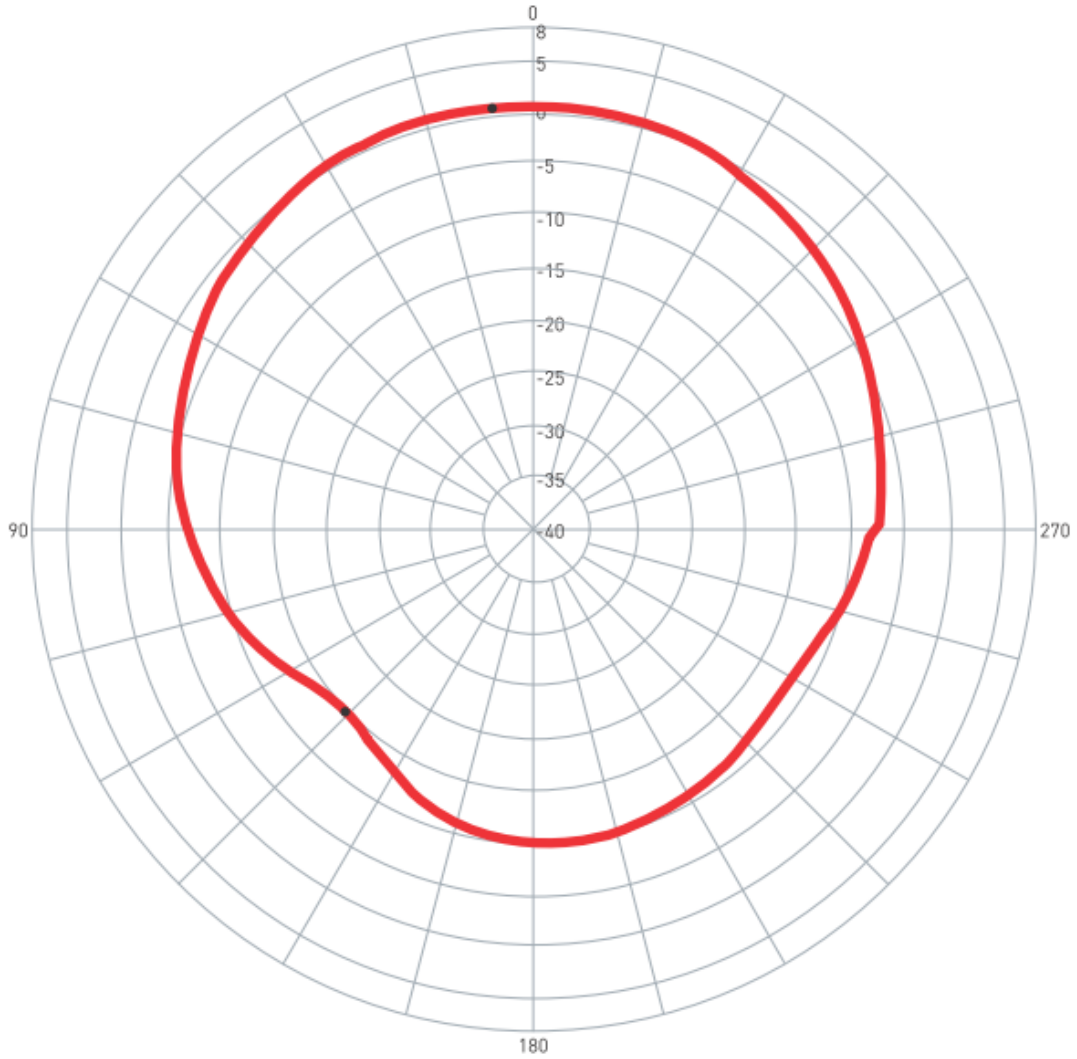

Figure 27. Radiation pattern at 2110 MHz, Figure 1 as reference (dB), with 2 m RG174 cable and 60x60 cm metal plate

5. System Block Diagram



6. GPS Patch Radiation Pattern



0 degree is the top of Hercules.

7. LNA Properties

7.1 LNA Gain and Out-band Rejection @ 3.0V

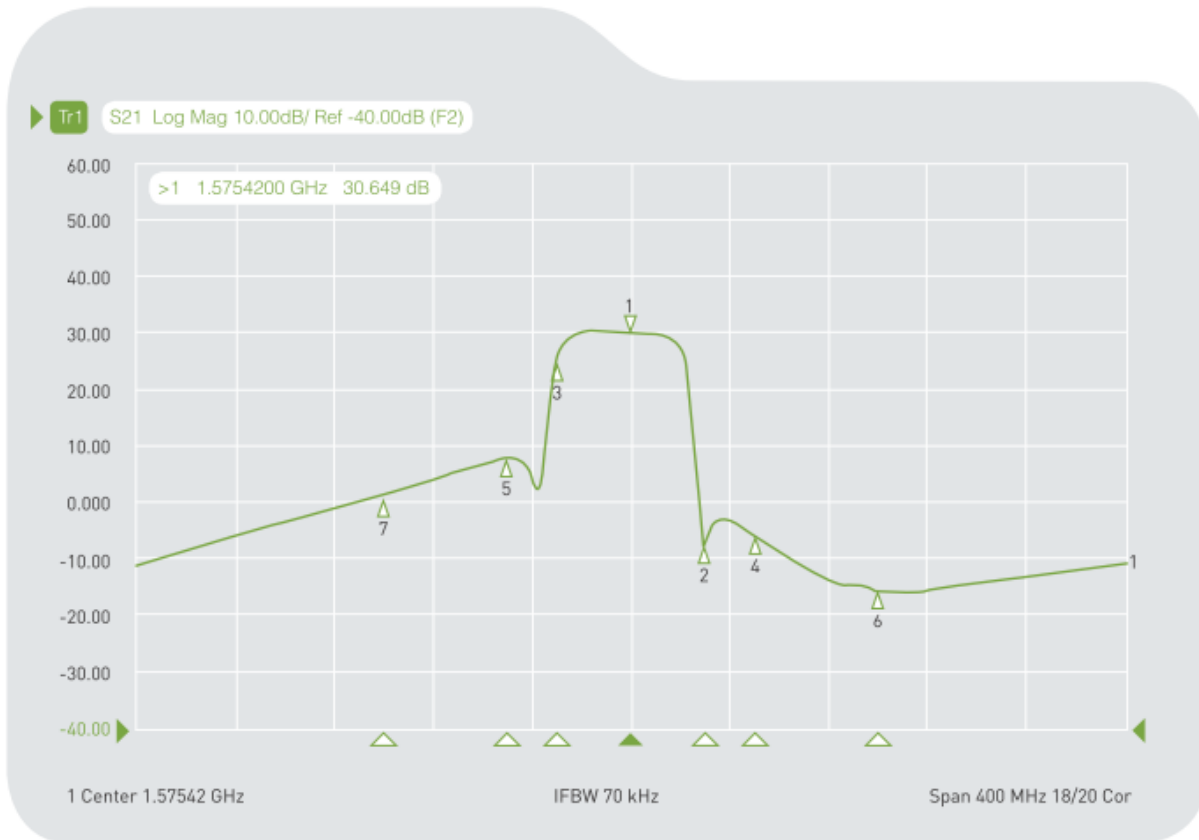

| | | | | | |
|-----|-----|-----|----|---------------|------------|
| Cg1 | Tr1 | S21 | >1 | 1.5754200 GHz | 30.649 dB |
| Cg1 | Tr1 | S21 | 2 | 1.6054200 GHz | -6.7098 dB |
| Cg1 | Tr1 | S21 | 3 | 1.5454200 GHz | 24.584 dB |
| Cg1 | Tr1 | S21 | 4 | 1.6254200 GHz | -5.6354 dB |
| Cg1 | Tr1 | S21 | 5 | 1.5254200 GHz | 8.0734 dB |
| Cg1 | Tr1 | S21 | 6 | 1.6754200 GHz | -15.436 dB |
| Cg1 | Tr1 | S21 | 7 | 1.4754200 GHz | -1.5714 dB |

7.2 Noise Figure

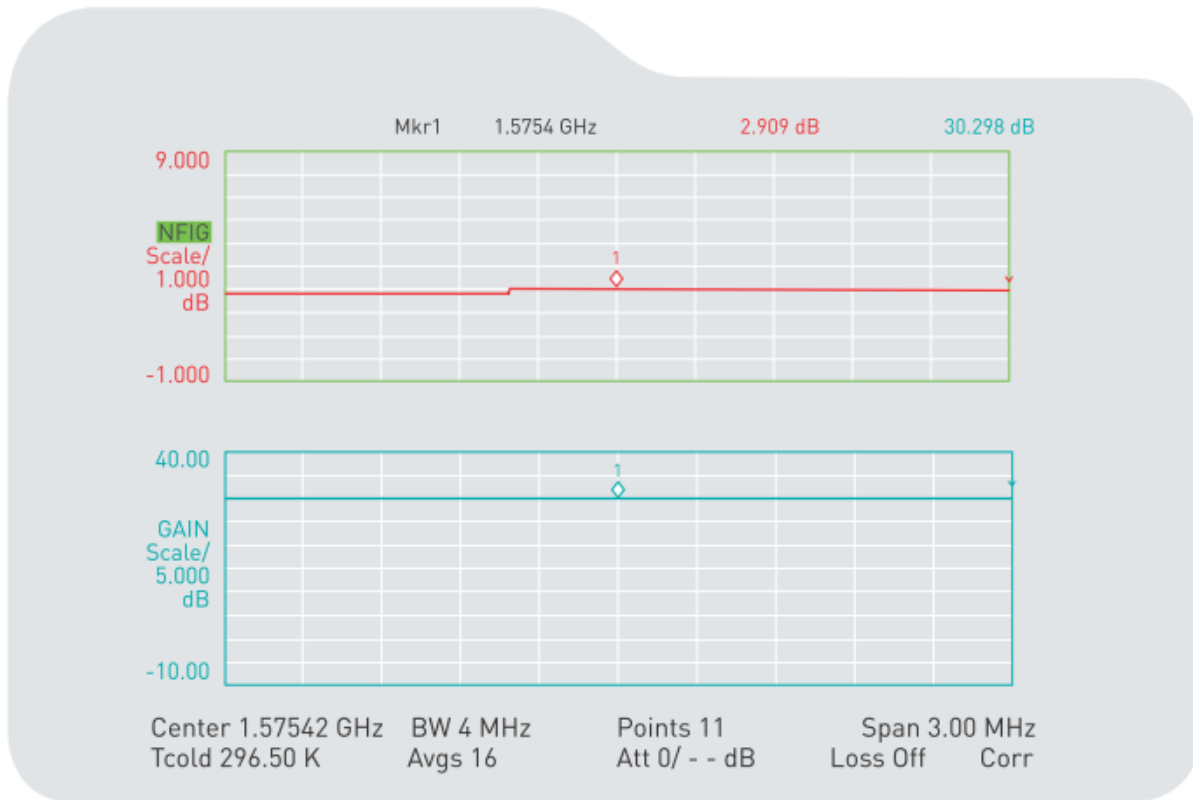

8. Drawing(unit:mm)

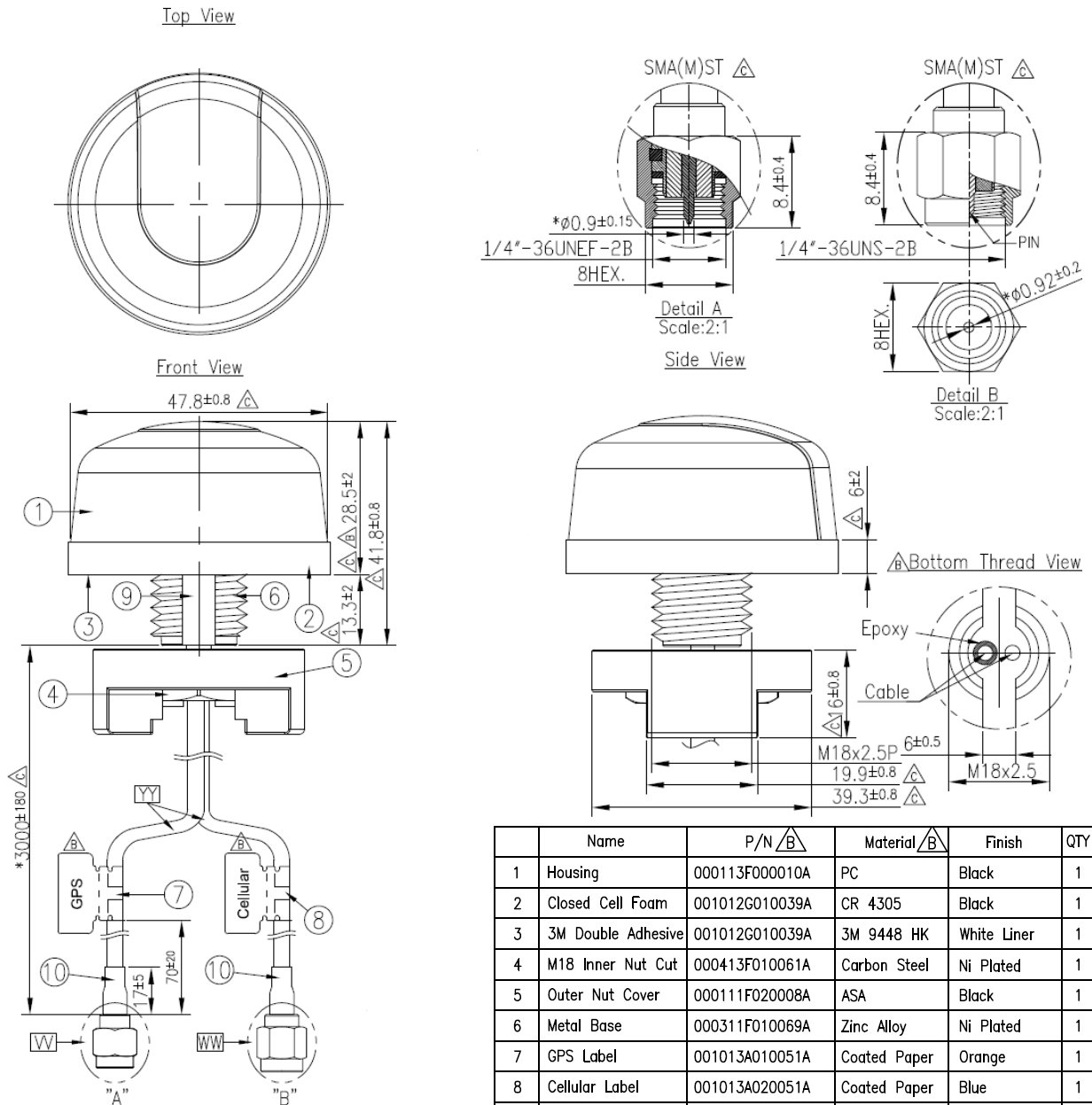

| | Name | P/N | Material | Finish | QTY |
|----|--------------------|----------------|-----------------|-------------|-----|
| 1 | Housing | 000113F000010A | PC | Black | 1 |
| 2 | Closed Cell Foam | 001012G010039A | CR 4305 | Black | 1 |
| 3 | 3M Double Adhesive | 001012G010039A | 3M 9448 HK | White Liner | 1 |
| 4 | M18 Inner Nut Cut | 000413F010061A | Carbon Steel | Ni Plated | 1 |
| 5 | Outer Nut Cover | 000111F020008A | ASA | Black | 1 |
| 6 | Metal Base | 000311F010069A | Zinc Alloy | Ni Plated | 1 |
| 7 | GPS Label | 001013A010051A | Coated Paper | Orange | 1 |
| 8 | Cellular Label | 001013A020051A | Coated Paper | Blue | 1 |
| 9 | Rubber Stopper | 000711F040064A | Silicone Rubber | Black | 1 |
| 10 | Heat Shrink Tube | 001315C020000A | PE | Black | 2 |
| | | | | | |
| | Name | P/N | Material | Finish | QTY |
| V | Connector Type | 200212G000007C | SMA(M)St | Au Plated | 1 |
| W | Connector Type | 200212G000013A | SMA(M)St | Au Plated | 1 |
| Y | Cable Type | 301315C000000A | RG174 | Black | 2 |

9. Installation

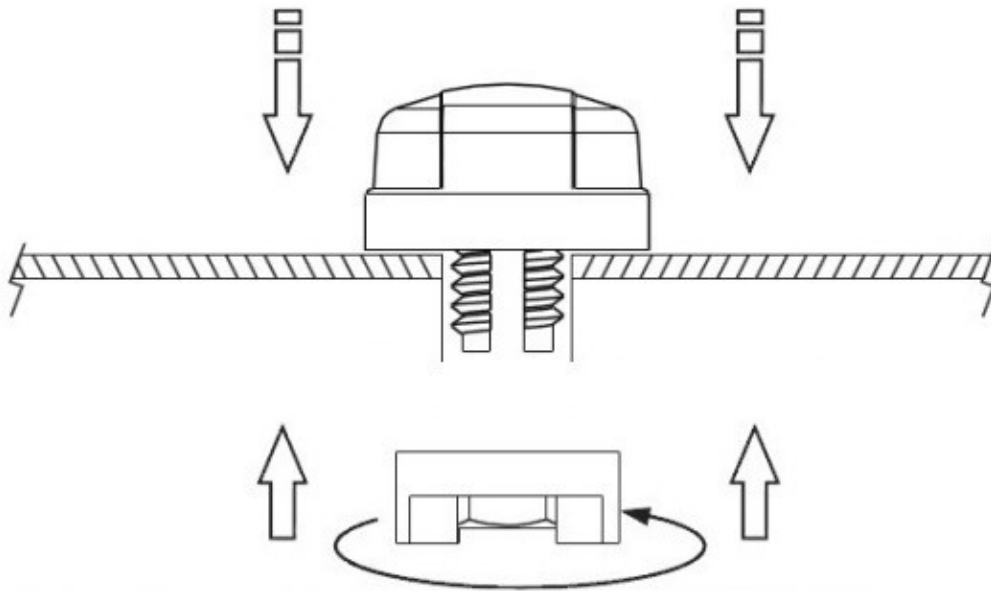

Recommended torque for Mounting is 24.5N·m
Maximum torque for mounting is 29.4N·m



10. Packaging

1pcs/PE Bag(160*300)
 SPQ-10pcs/PE Bag(280*450mm)

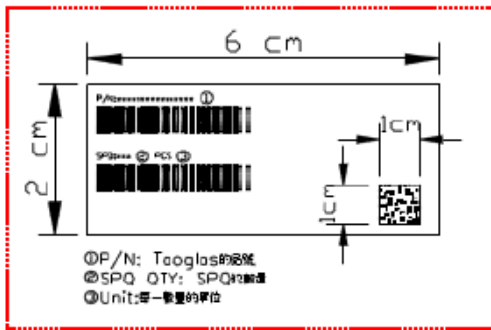

Label 1

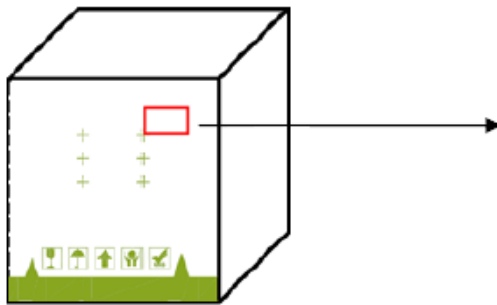
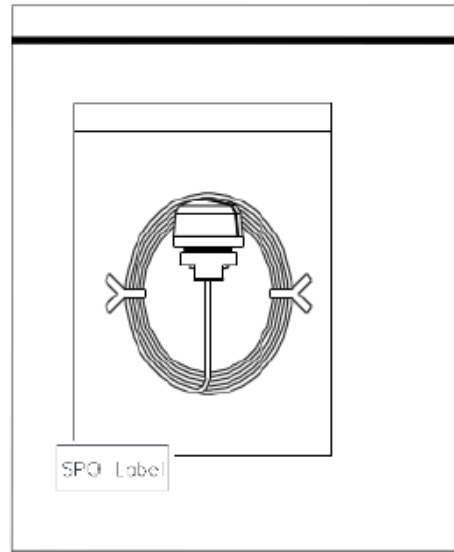

60pcs/Carton
 (390*260*330mm)





Taoglas makes no warranties based on the accuracy or completeness of the contents of this document and reserves the right to make changes to specifications and product descriptions at any time without notice. Taoglas reserves all rights to this document and the information contained herein.

Reproduction, use or disclosure to third parties without express permission is strictly prohibited.

Copyright © Taoglas Ltd.